

# Serving Incarcerated Veterans



# ▶ Veteran Initiatives:

In Pennsylvania, there are an estimated 4,848 veterans incarcerated in Pennsylvania Department of Corrections (PADOC) facilities and under the supervision of the Pennsylvania Board of Probation and Parole (PBPP).

A collaborative effort has been established between the PADOC and the PBPP to address the unique needs of our veteran population.

John Wetzel, Secretary, Pennsylvania Department of Corrections

Michael Potteiger, Chairman, Pennsylvania Board of Probation and Parole



# Veteran Initiatives:

## Agency Support Staff:

Christopher E. Reed, MBA, Veterans Coordinator, PADOCC

Otis Nash, Veteran Service Unit Project Manager, PADOCC

Krista Griffith, Parole Manager, Offender Reentry, PBPP

## ▶ Veteran Initiatives:

"When you made the choice to serve your country in the Armed Forces, you wrote a blank check to all the citizens promising to defend their freedom and way of life unconditionally. This program is our way of letting you know that we have not forgotten that commitment despite whatever circumstances you are in."

Arizona Sheriff Joe Arpaio

**LEAVE NO ONE BEHIND!**

# Veteran Initiatives:

## PADOC State Correctional Institutions (SCI)

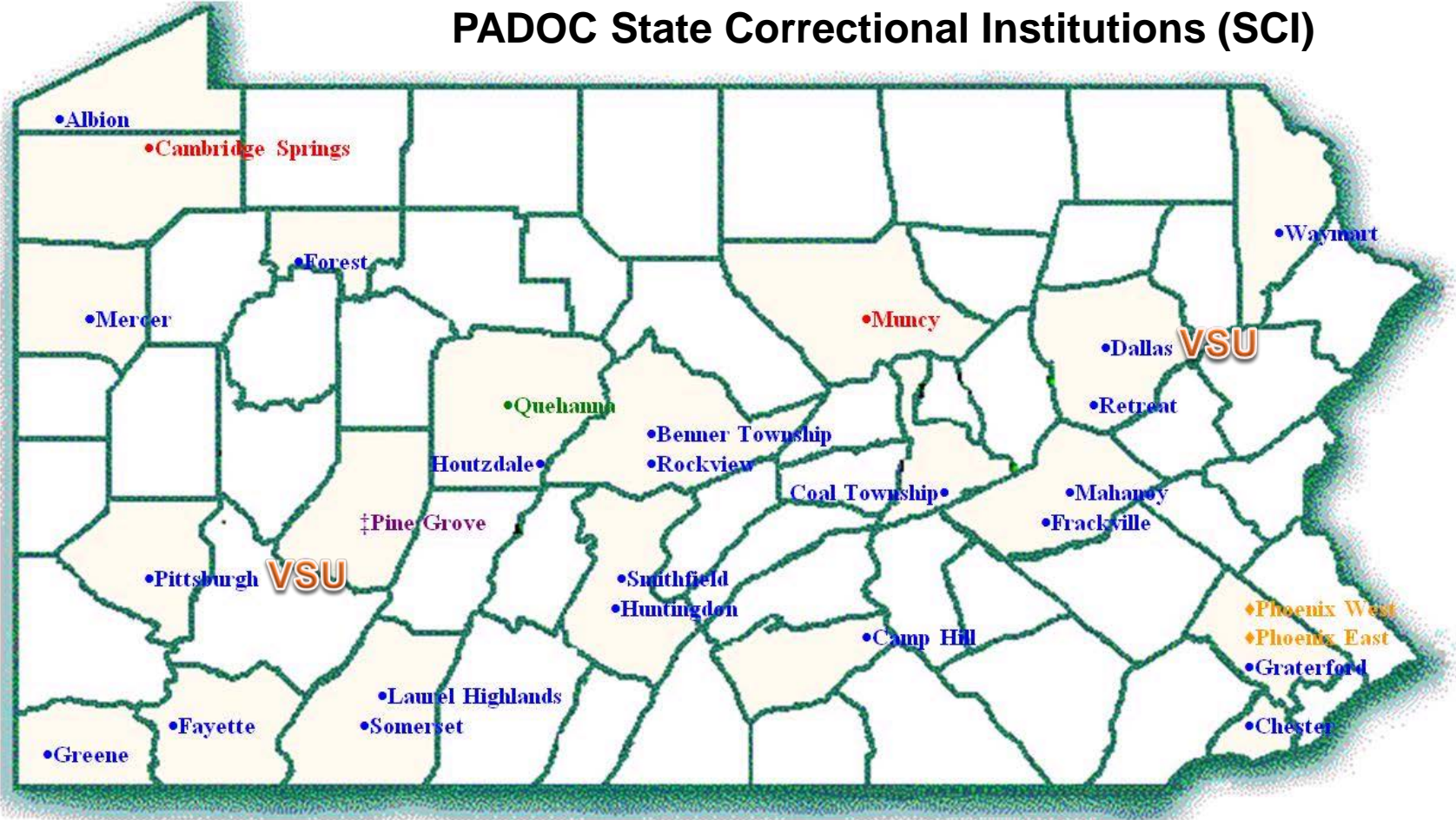

# Veteran Initiatives:

## PA Board of Probation and Parole

Location of Region, District, Sub and Correctional Institution Field Offices

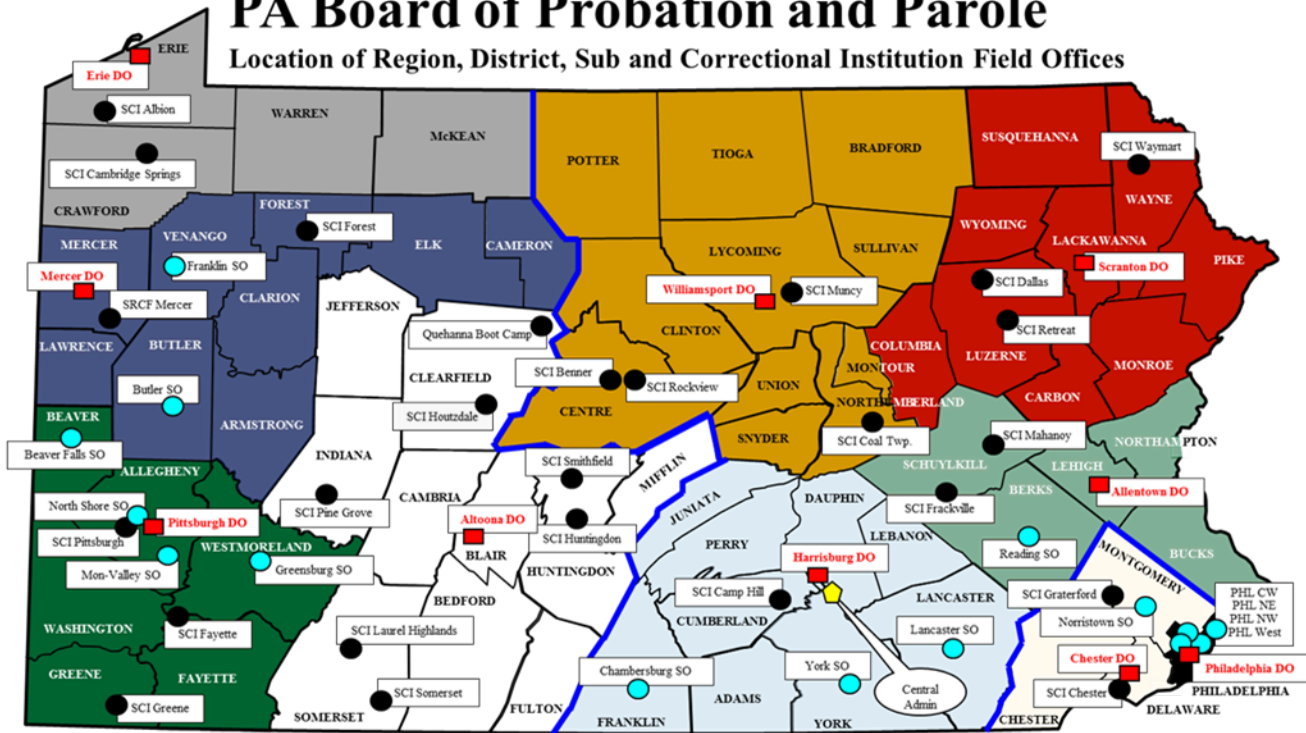

**Western Region**

Erie District	Altoona District
Mercer District	Pittsburgh District

**Central Region**

Williamsport District	Harrisburg District
Scranton District	Allentown District

**Eastern Region**

Chester District
Philadelphia District

- PBPP District Office (10)
- PBPP Sub-Office (15)
- State Correctional Institution (26)

# Veteran Initiatives:

## The Sequential Intercept Model

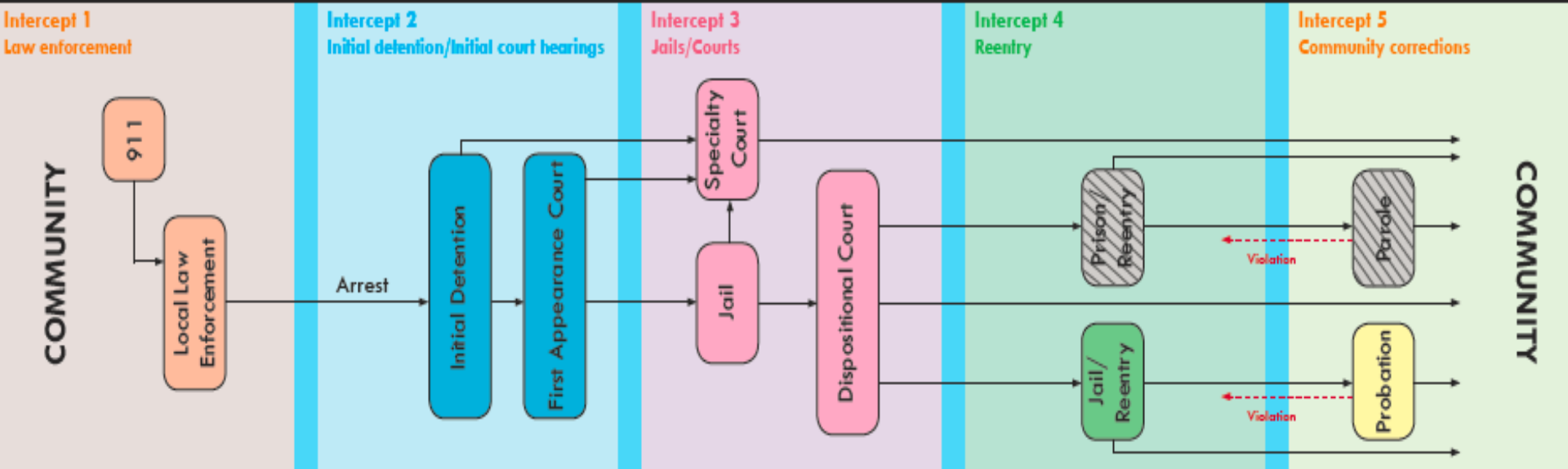

# ▶ Veteran Initiatives:

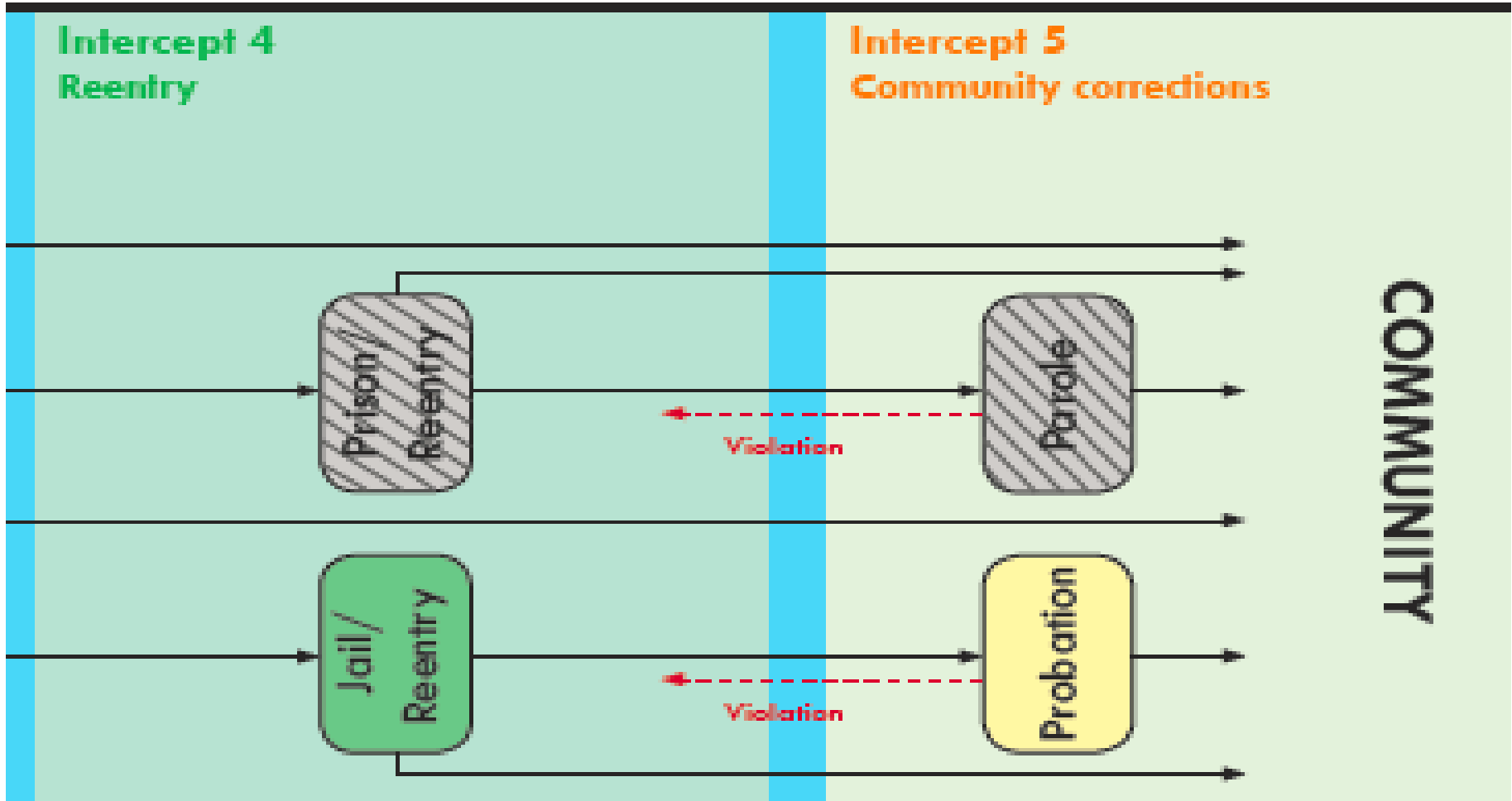

# ▶ Veteran Initiatives:

## Intercept 4 Reentry

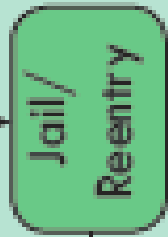

Reception – 18-36 months from release

Reentry starts at Reception!

- Identify and Verify Status
- Obtain DD214
- Discharge Upgrade Seminars
- Birth Certificates
- Social Security Card
- Correctional Plan
  
- Institution VA Coordinator
- Unit Management Team
- Treatment Specialist
- DATS
- PSA
- Institution Parole
- VA Reentry (HCRV)

# ▶ Veteran Initiatives:

## Intercept 4 Reentry

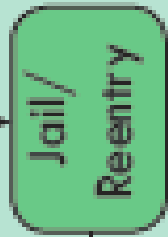

36 months from release - Release

Veteran Service Units

- Correctional Plan
- Discharge Upgrade Seminars
- Eligibility for Health Care / VA Enrollment
- Workshops
- Home Plans / Continuity of Care
  
- Institution VA Coordinator
- VSU Unit Management Team
- Social Worker
- Treatment Specialist
- DATS
- PSA
- Institution Parole
- Parole

# ▶ Veteran Initiatives:

## Intercept 5 Community corrections

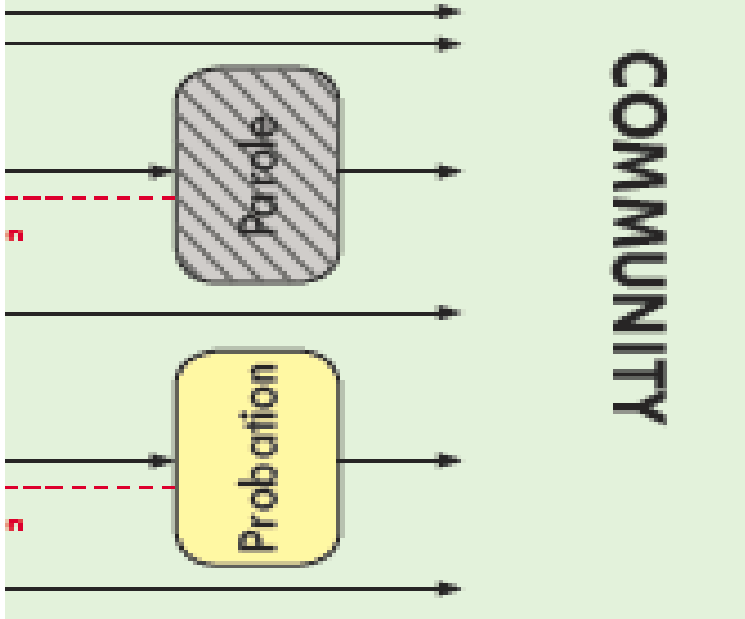

Tomorrow's Hope – Coalport, PA  
Adappt – Reading, PA

- Reconnect Service Disabilities
- AA / NA
- Vocational and Educational Training
- Employment Skills
- CWT
  
- Facility Manager
- Case Manager
- Parole
- VA Medical Staff
- VA Support Staff
- VA Homeless Coordinator
- VSO and Community Partners

# ▶ Veteran Initiatives:

## IDENTIFICATION

- Access to veteran services for reentry planning begins with positive identification.
- The PADOC and the PBPP both use the Veteran Reentry Search Service (VRSS) available from the Veterans Administration (VA) to initially identify inmates and offenders as veterans.
- Veteran status is confirmed with receipt of a DD-214.
- A Veterans Coordinator at each State Correctional Institution (SCI) assists veterans with document requests.

# ▶ Veteran Initiatives:

## Veteran Service Units (VSU)

- Located at SCI Dallas (vicinity of Wilkes Barre, 156-bed capacity) and SCI Pittsburgh (48-bed capacity).
- Eligible veteran inmates volunteer to participate and arrive at the VSU approximately 9-18 months prior to release.
- Participants receive tailored workshops and services to meet their reentry needs.
- VSU staff consists of: Unit Manager, Reentry Specialist, Reentry Parole Agent, Social Worker, Treatment staff, Psychology staff, Security staff, Veteran Coordinator, etc.

# Veteran Initiatives:

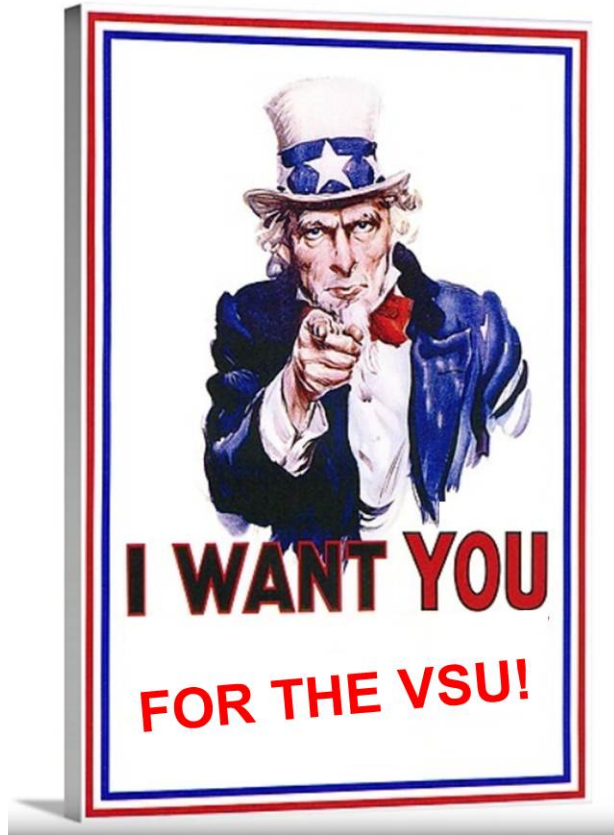

- Are you an incarcerated veteran?
- Are you 9-18 months from your minimum or release?
- Are you interested in being on an all Veteran Housing Unit?
- Are you interested in obtaining all your entitled **VA Benefits**?
- Are you interested in learning more about the **American Legion, Vietnam Veterans of America, The VFW** and other Veteran Service Organizations?
- Are you willing to participate in reentry **Workshops** specifically geared for veterans as you transition back into society?
- Are you a **long-termer** looking for an opportunity to contribute to the veteran community as a peer facilitator?

# ▶ Veteran Initiatives:

## VSU Workshops:

Stay on Track

Parenting

Relationships

Healthy Living

Vocational Certification

Seeking Safety

Computer Basics

Mental Health

Budgeting

Employment

Housing Workshop

Renter's Workshop

## Rap Group

# ▶ Veteran Initiatives:

## PBPP Services:

Orientation (1-module)

Living Under Supervision (4-modules)

- Understanding parole
- Conditions of supervision
- Parole handbook
- Preparing for their return to the community

Real Colors® (1-session)

One-on-One Interventions

- Cognitive behavior interventions addressing: companions, attitudes/beliefs, temperament, family, D/A, education/employment, and leisure activities

Reentry Planning

# ▶ Veteran Initiatives:

## Veteran Offender Aftercare

- Upon release to the community, Parole Agents provide intake, ensure compliance for conditions of supervision including any treatment requirements and referral needs.
- Select Parole Agents within PBPP's ten (10) Districts liaison with Veterans Administration (VA) staff to assist eligible veteran offenders with needs including housing, medical, mental health treatment, drug and alcohol services, vocational and educational support, etc.
- Parole Agents also develop networks with community based service providers to assist veteran offenders ineligible for VA assistance.

# ▶ Veteran Initiatives:

## Veteran Offender Housing Alternatives

Eligible veteran offenders that are unable to obtain an approved home plan may be able to reside at one of the six (6) Veterans Homes:

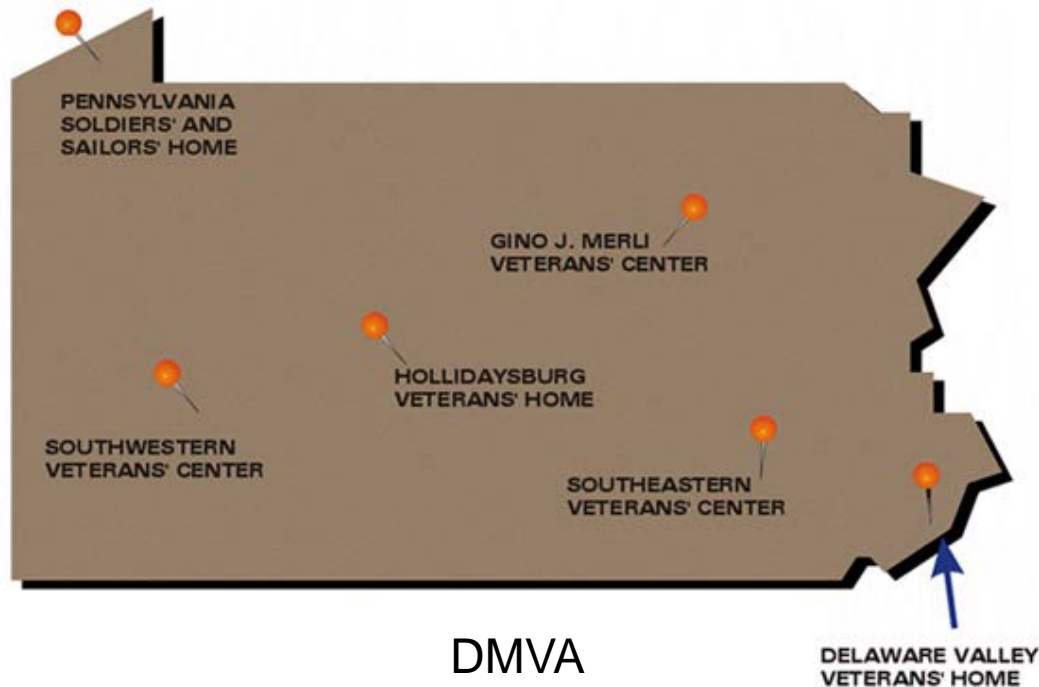

# ▶ Veteran Initiatives:

## Veteran Offender Housing Alternatives And Aftercare Services

- Vietnam Veterans of America
- PA Prison Society
- Delaware County Reentry Program
- PA Justice Project of Chester, PA
- Delaware Center for Homeless Veterans (DCHV)
- Delaware County Reentry Housing Initiative (Mr. Richard Carter)
- Tomorrow's Hope (Coalport)
- Adappt (Reading)
- Robert M. Jackson Veteran Center (Harrisburg)
- Scranton Catholic Social Services
- Fresh Start, Inc.
- American Legion, Harrisburg and Wormleysburg
- VA Grant Per Diem Sites (33)
- VISN 4 Edward Sesak
- VISN 4 Ebony McDonald

# ▶ Veteran Initiatives:

## Goals:

1. Provide collaborative staff training to better support veteran offenders
2. Enhance partnership between agencies and community partners
3. Better identification of veteran offenders
4. Improve community partner acceptance for hard to place veteran offenders

# > Veteran Initiatives:

Contact us:

Chris Reed  
PADOC  
814-378-1000  
[chreed@pa.gov](mailto:chreed@pa.gov)

Otis Nash  
PADOC  
717-728-0392  
[c-onash@pa.gov](mailto:c-onash@pa.gov)

Krista Griffith  
PBPP  
717-787-5699  
[kgriffith@pa.gov](mailto:kgriffith@pa.gov)

# ▶ Veteran Initiatives:

## New Leash on Life



# ▶ Veteran Initiatives:

Questions?